



UML

in het zicht van de ontwikkelaar



TRAINING & CONSULTING

Geert Vandevenne
Instructor & Consultant
gvandevenne@abis.be

- Positioning UML
- UML and development processes
- Overview of a few important diagrams
- Relationships between diagrams

- UML (1997): common set of modeling constructs and notations



- Rumbaugh, Booch and Jacobson
(tres amigos)
- NOT a development process
- V1.5 (2003) ----- V2.0 (2004)

- Provide expressive (*visual*) modelling language
- Be independant of
 - programming language
 - process
- Encourage OO tools market

- Flexible and extensible
 - OCL (Object Constraint Language)
 - UML Profiles
- Support higher-level reuse concepts

- UML is NOT a development process
- OO Development processes
 - (R)UP : Rational Unified Process (1999)
 - Extreme Programming
 - DSDM
 - Scrum

- Requirements
 - use case diagram
- Static structure
 - class diagram
 - object diagram

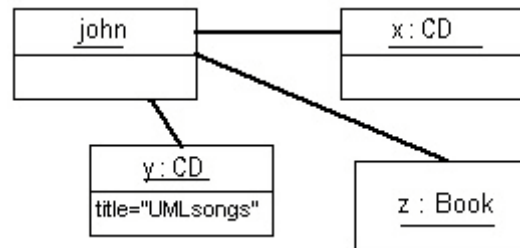
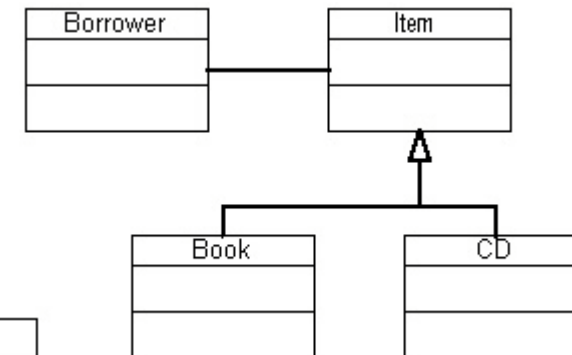
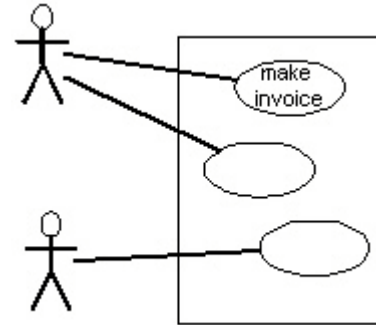

- Dynamic behaviour
 - sequence diagrams
 - collaboration diagram
 - statechart diagram
 - activity diagram

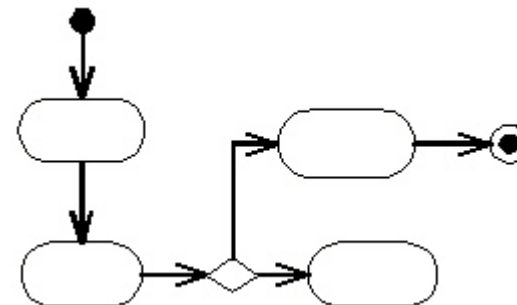
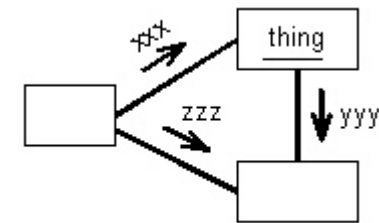
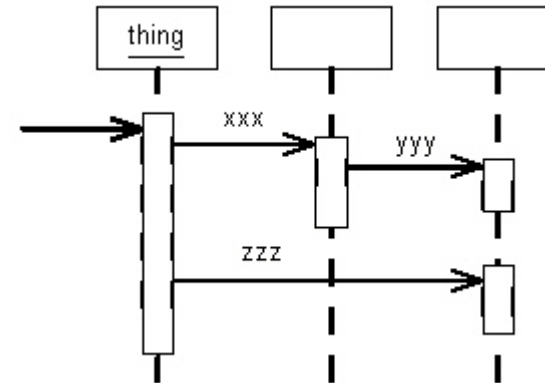

- Achitectural
 - package diagram
 - component diagram
 - deployment diagram

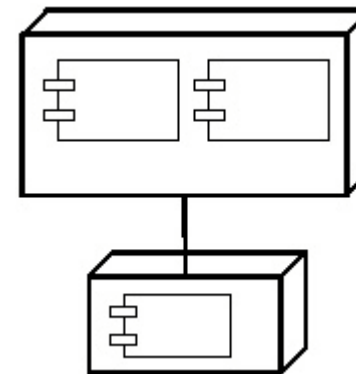
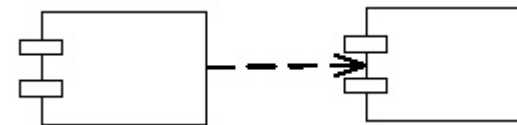
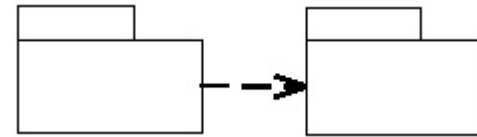

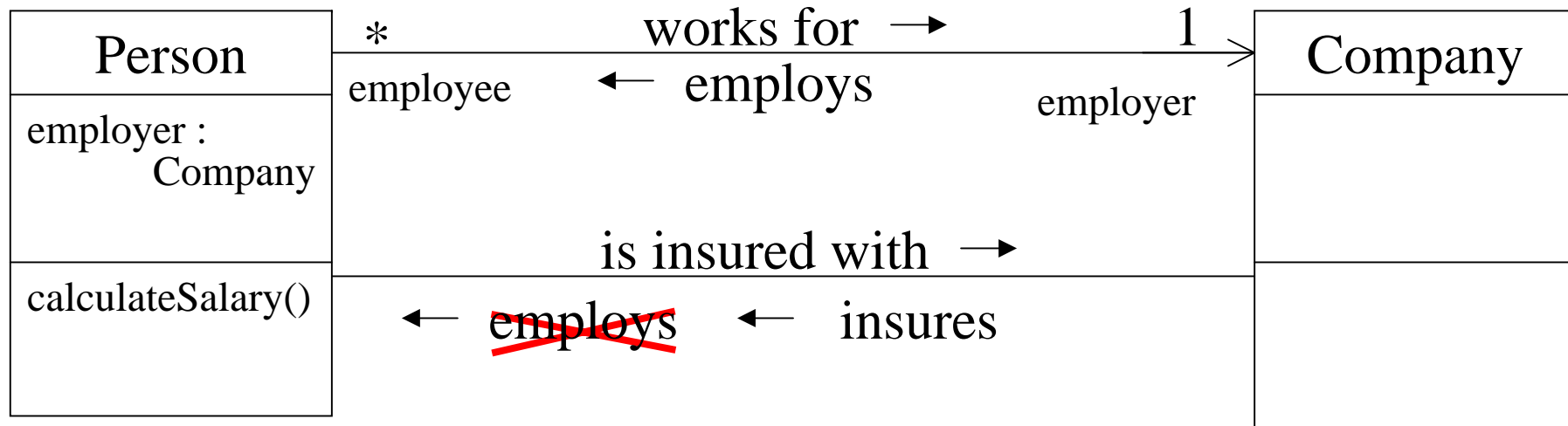

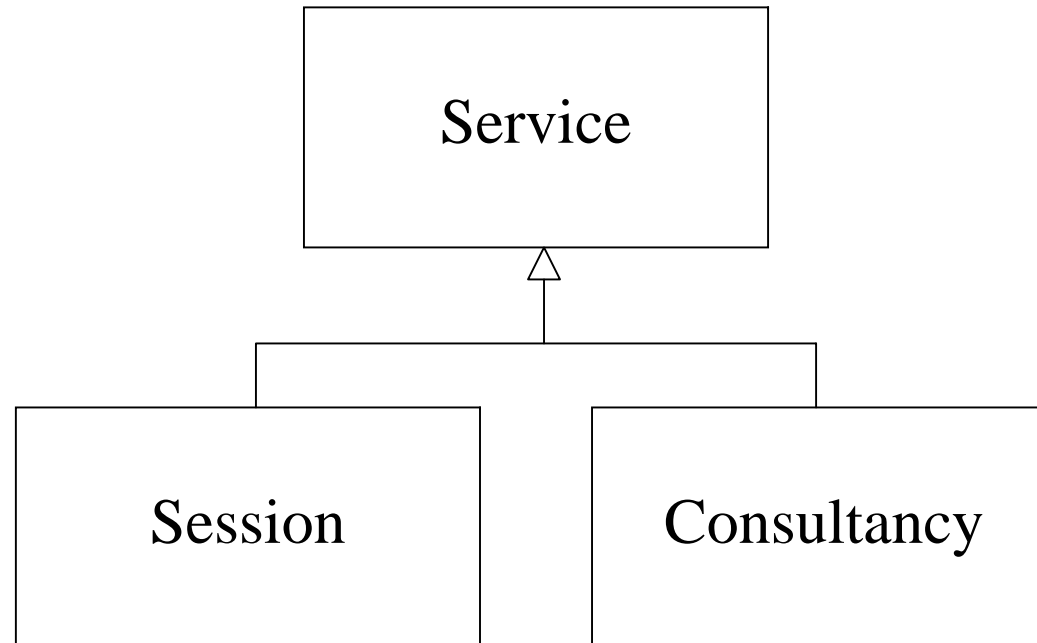

- Domain model
 - no navigation
 - no operations
 - no implementation detail

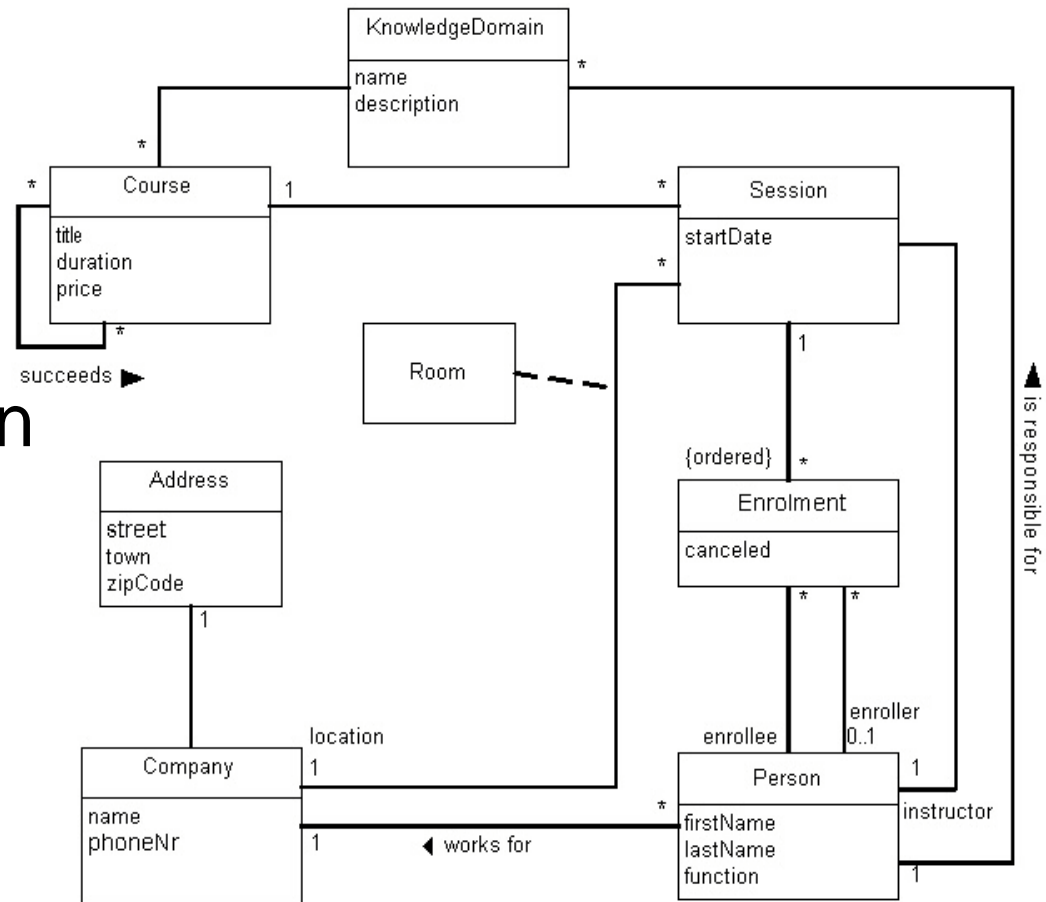

- Software classes

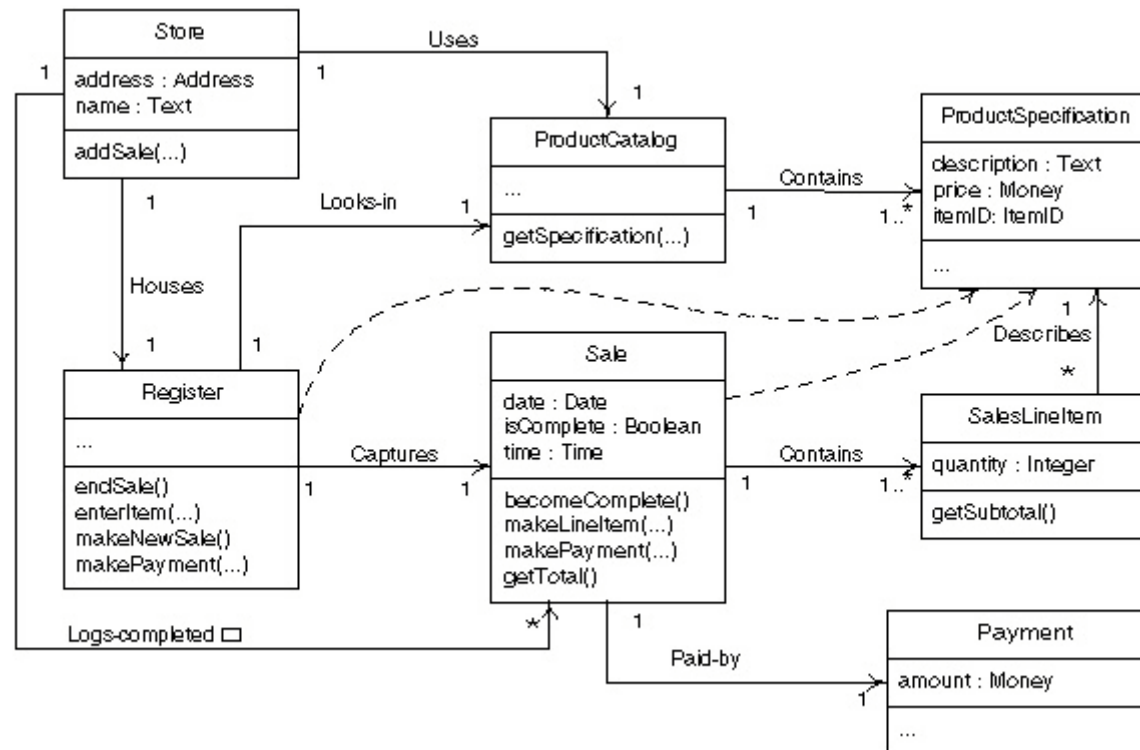

- Clarify concepts
(e.g. J2EE Business Delegate)

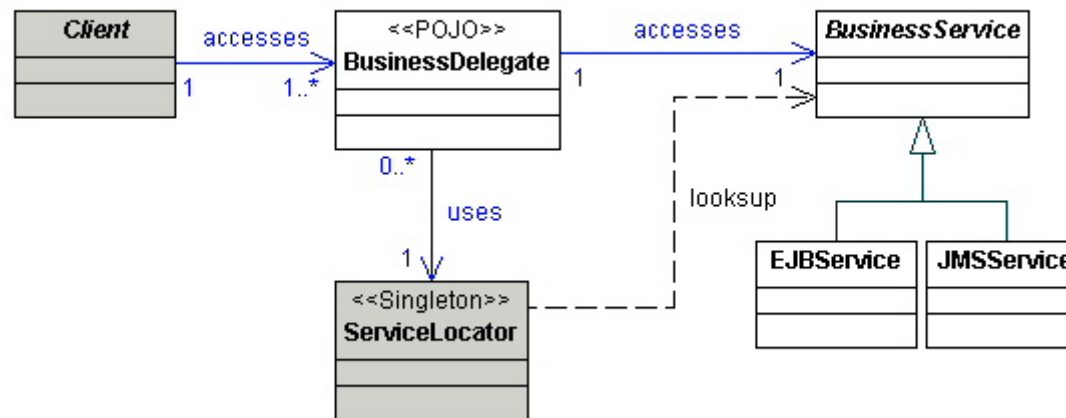

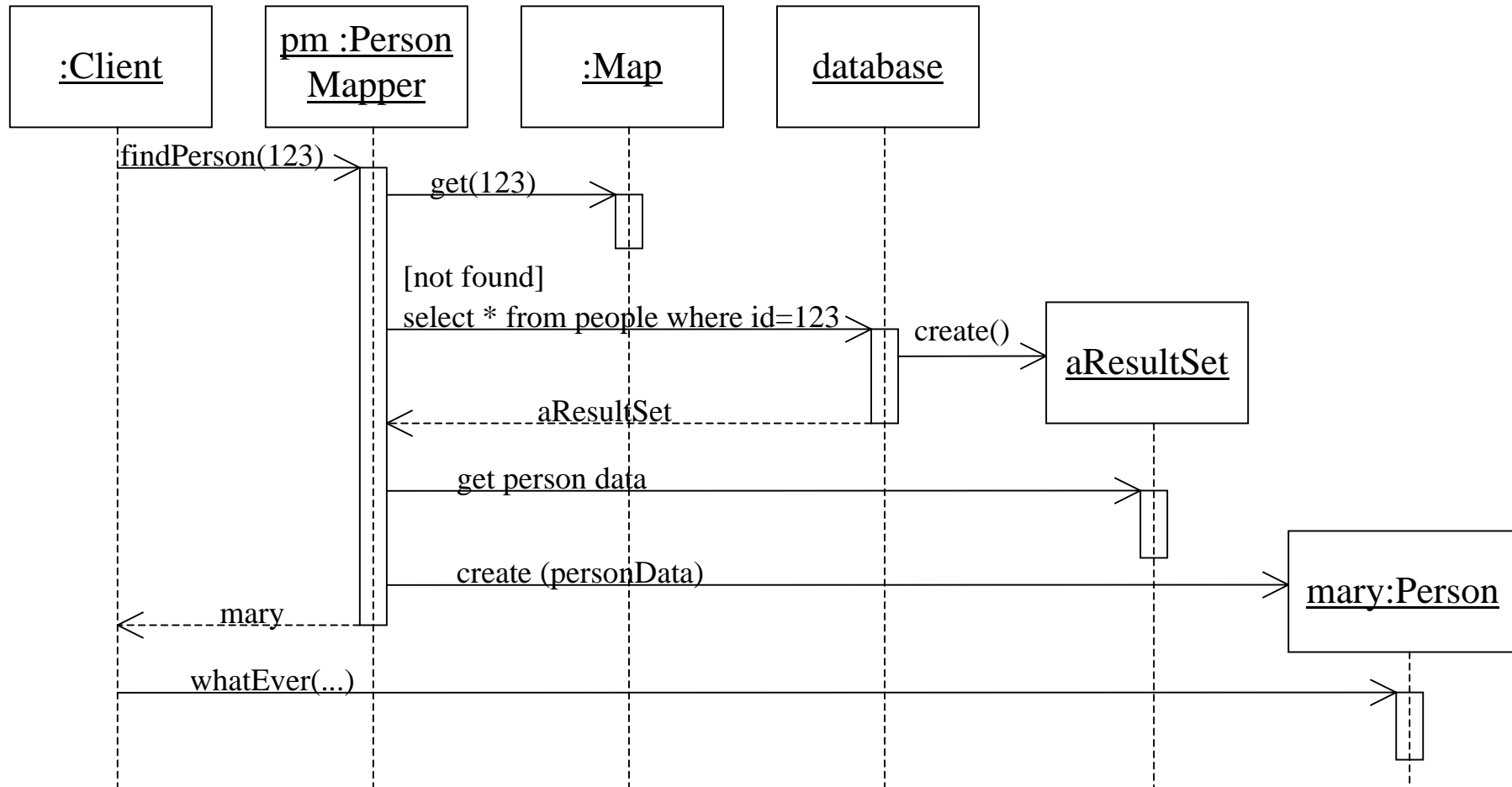

- Analyse scenarios in use cases

...

4. The user indicates he wants a list of annulated enrolments for that specific course.

5. The system looks up the sessions for that particular course.

6. The system looks up the list of annulated enrolments for each session.

...

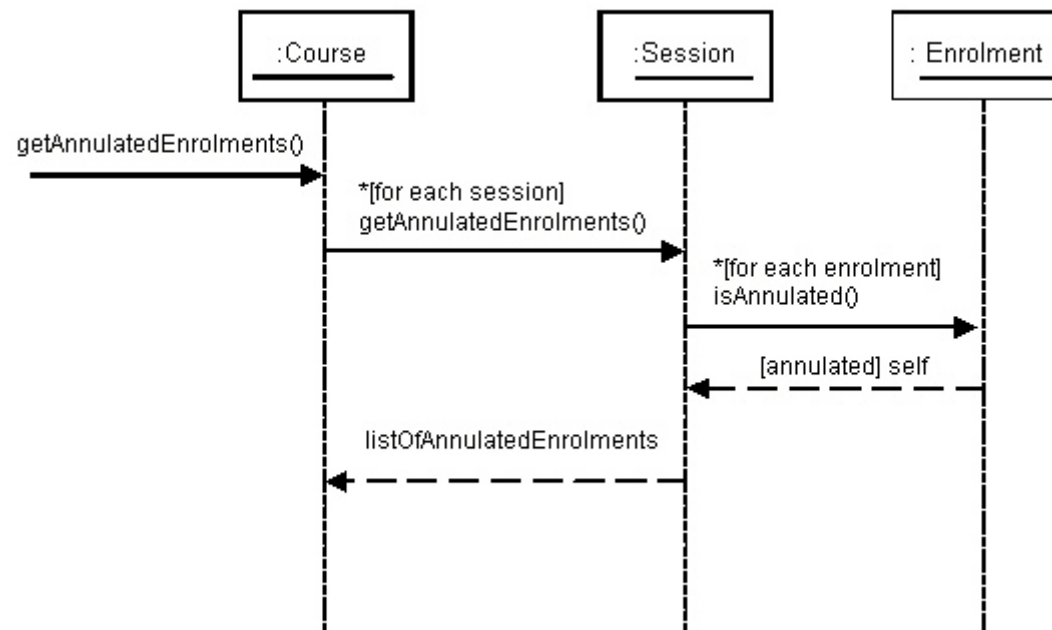

- System sequence diagrams

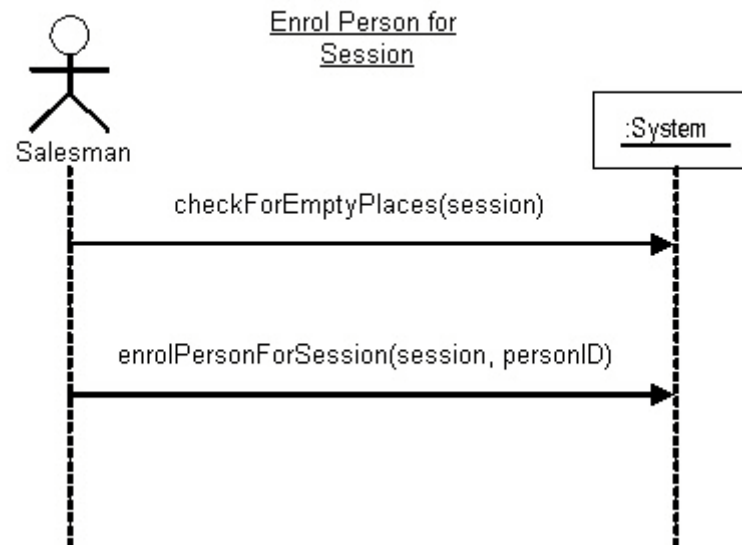

- Communication between components

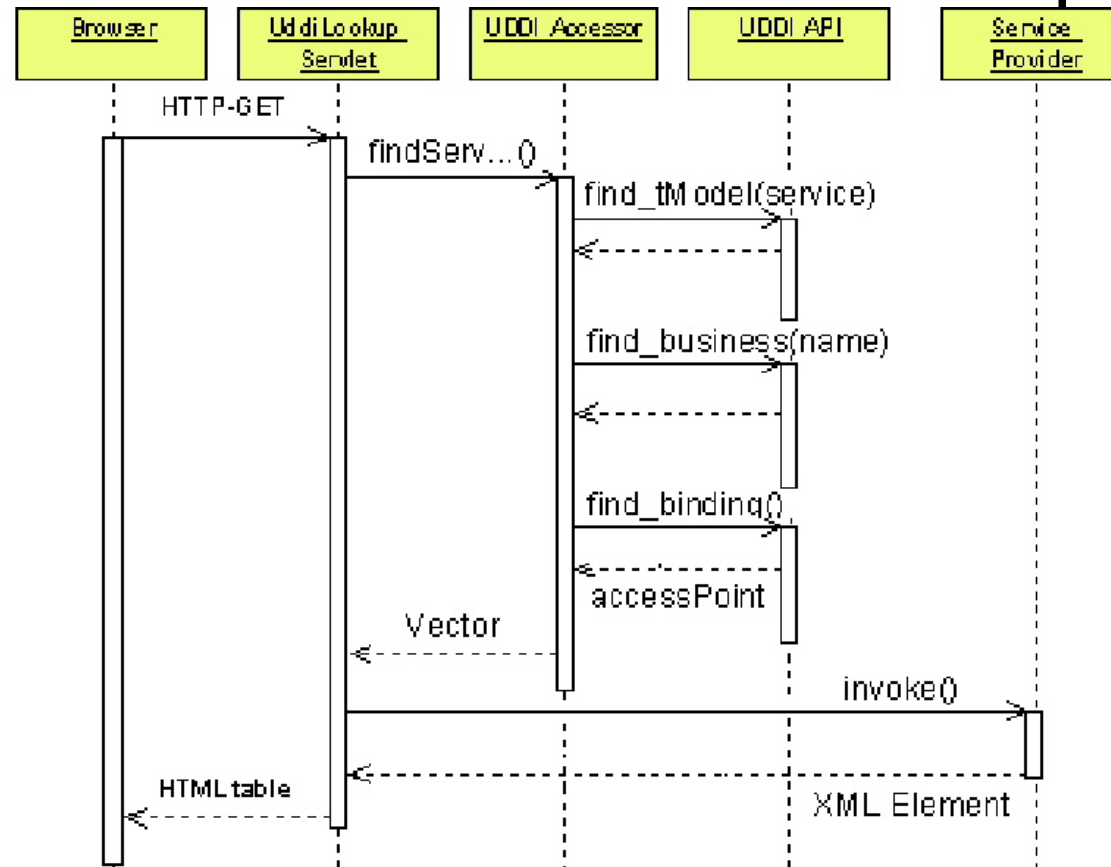

- Messages translate into operations

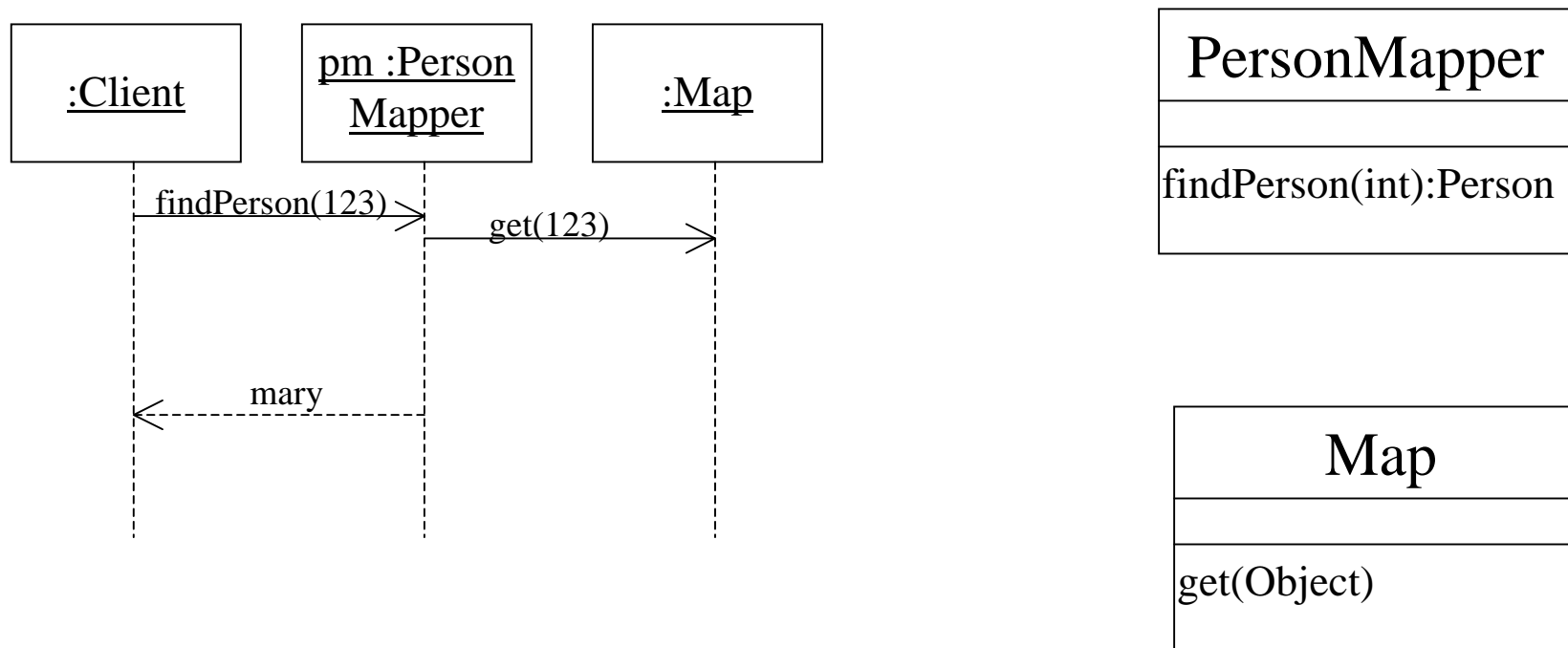



Q&A

abis

TRAINING & CONSULTING

<http://www.abis.be>

Thank you

abis

TRAINING & CONSULTING